



**CoDiS** Machine Condition Monitoring system for Motors, Pumps, Compressors



Product brochure

VIBRATION EXPERT SYSTEMS  
CONSULTING  
SYSTEM DESIGN

## PREDICTIVE MAINTENANCE

On-line monitoring system Power producing plants ensures continuous monitoring of exploitation and is a critical step toward predicting mechanical behaviour. The real benefit is the predictive capability for malfunctions and identification of irregularities in system behaviour which can significantly improve repair planning and scheduling and can also prevent additional damage from occurring.

Modern monitoring systems include vibration monitoring, monitoring of electrical parameters and process parameters (temperatures, pressures, flow etc.).

System must include continuous measurement, trending and database creation of all measured data. Substantial and well structured database ensures

organized and cost effective maintenance planning. Repair works based on the exploitation state can significantly reduce the maintenance cost, up to 50 %. Modern monitoring systems are based on network communication and data transfer with other systems installed in Power producing plants using standard industrial protocols (modbus, profibus).

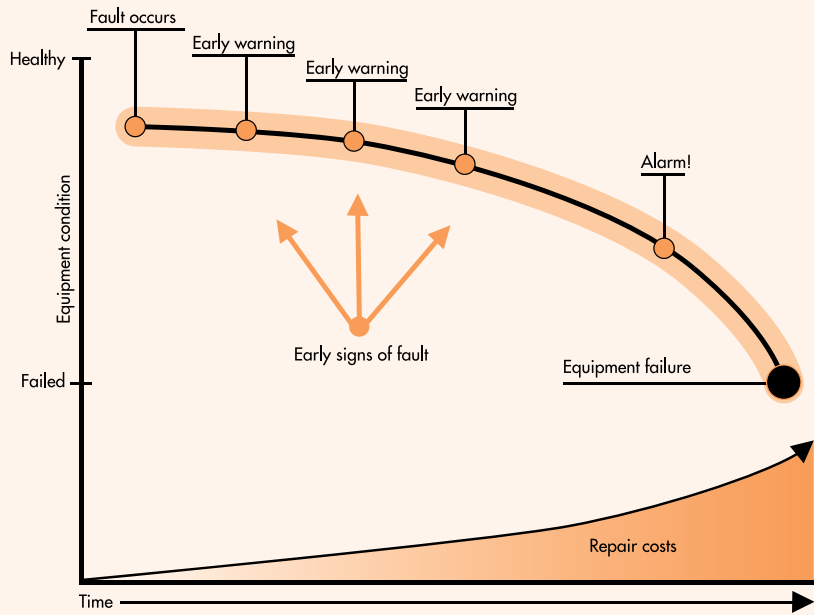

### BENEFITS OF CONDITION MONITORING

- Efficient repairs
- Better maintenance planning
- Permanent change detection
- Damage prediction
- Damage prevention
- Fault diagnosis and detection

## CoDiS MACHINE CONDITION MONITORING SYSTEM

The system used for early warning and predictive maintenance of rotating machines in power plants and processing industry. **CoDiS** architecture includes Real Time protection and alarming system (**CoDiS RT**), and integrative software module for diagnostic monitoring (**CoDiS DM**).

The key advantage is based on open software architecture which enables flexible configuration of the system, easy customization for end user and easy future upgrades.

CoDiS monitoring is based on rugged National Instruments CompactRIO technology as processing and data acquisition hardware running on RT operating system.

Controllers are used for safety purposes and high priority tasks such as machine shutdown, communication with SCADA and Control systems.

Server PC running on Windows OS are used for off line analysis, database storage and data distribution to remote users.

Users can access CoDiS server application, on-line data as well as CoDiS database, from any remote location.



## CoDiS SYSTEM LAYOUT

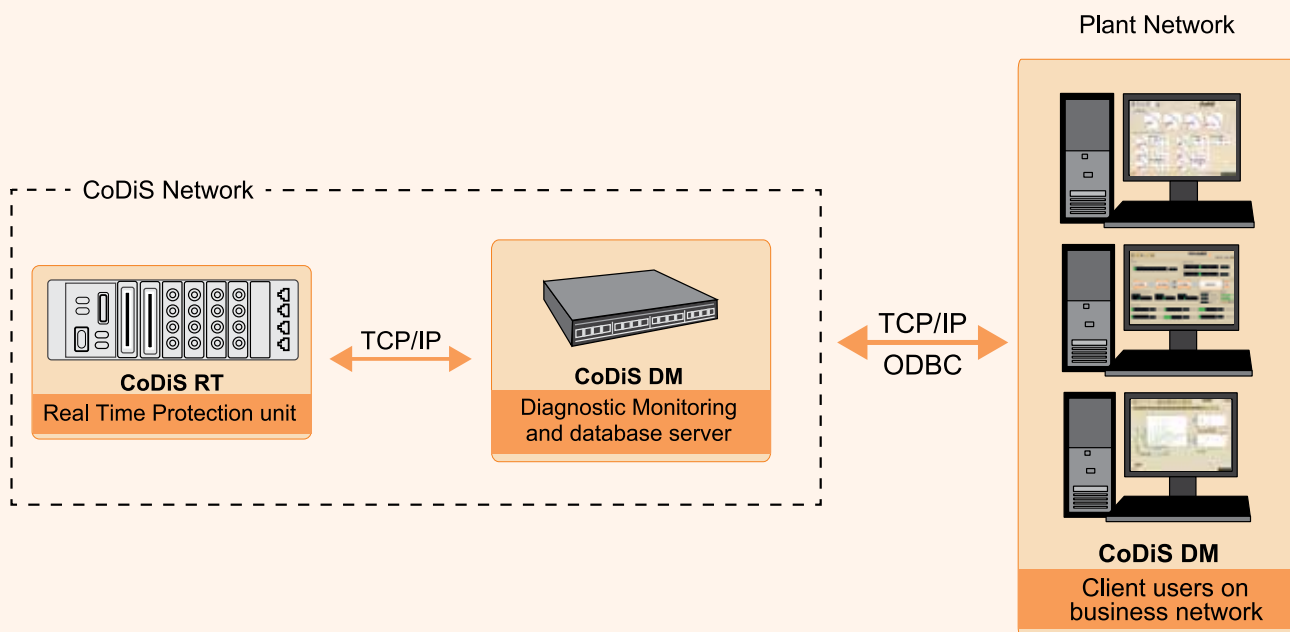

## CODIS MODULES

### „CoDiS RT” – real time protection and alarming

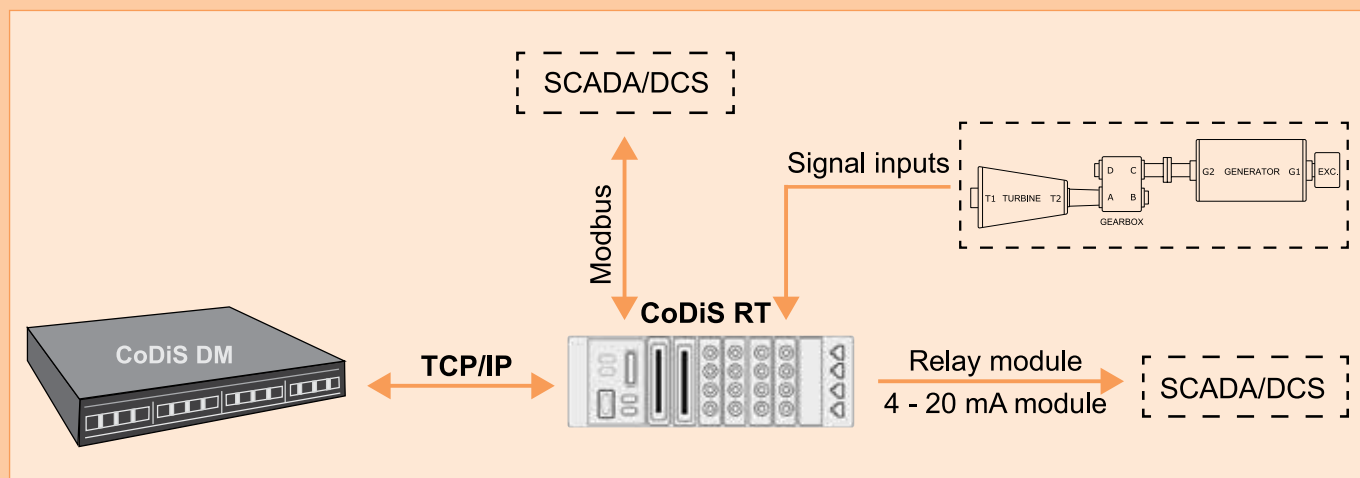

#### CoDiS RT tasks:

1. Performs real time analysis on all measured signals
2. Analyzes different operating conditions (i.e Stop, Run Up, Normal operation, User defined condition)
3. Triggers relay and alarm notifications
4. Sends condition vectors (calculated values) to the Server
5. Sends signal waveforms to the Server
6. Communicates with SCADA or DCS
7. Receives the orders from the server (user created event recording, configuration and setup etc.)
8. Time synchronization



„CoDiS DM“ is diagnostic platform and is used to create history database of all measured values and created events.

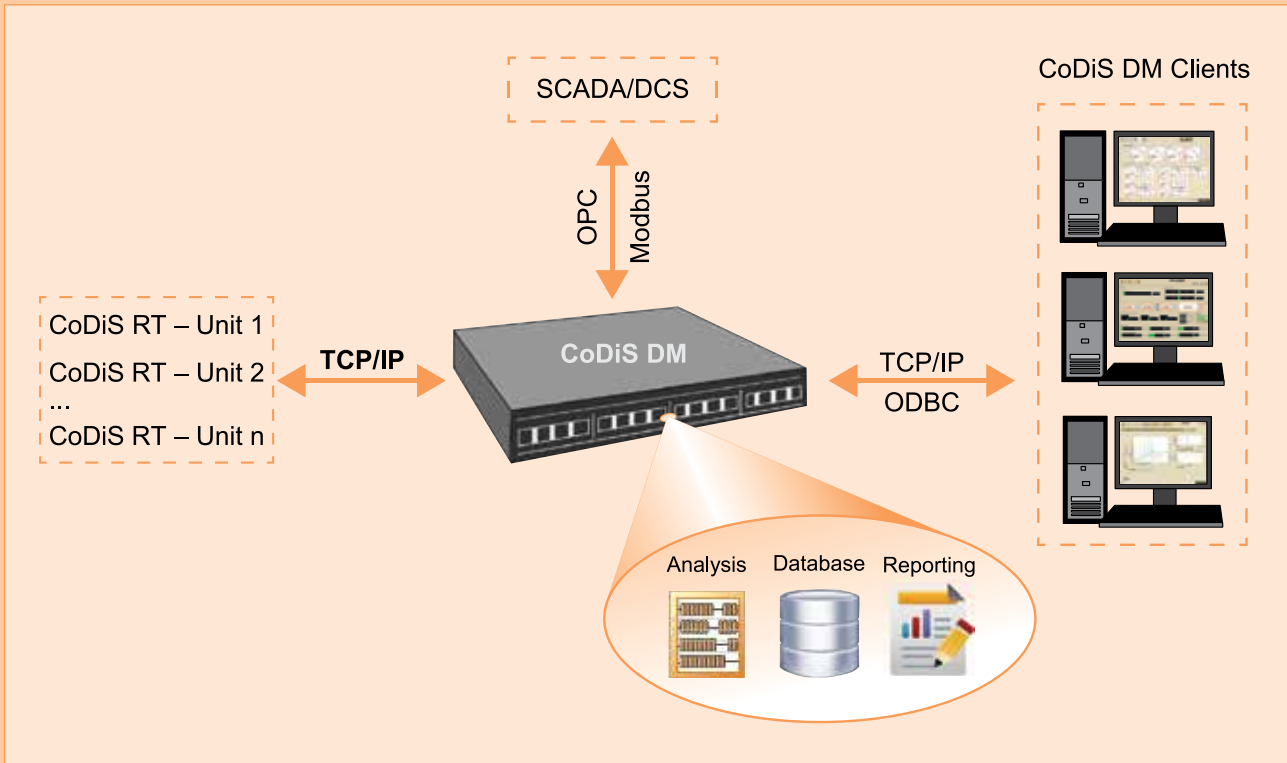

**CoDiS DM tasks:**

1. Receives the Condition Vectors from CoDiS modules and performs history data storage and event recording in MySql database
2. Evaluates the operating conditions and stores the data accordingly
3. Receives Alarm notification from CoDiS modules
4. Communicates with SCADA or DCS via OPC
5. Performs the time synchronization of CoDiS modules

The system creates a database of each measured signal continuously while in operation constantly obtaining data from all CoDiS unit. Diagnostic monitoring module CoDiS DM is used for predictive maintenance, to detect permanent changes in machine performance and to track the condition changes in early phase.

Diagnostic monitoring provides continuous on-line data analysis, database recording and is responsible for data distribution to client users.

Each event is archived and user has capability to track all the changes and apply diagnostic tools to extract the essential information and highlight the problem.

**STANDARD DATA ANALYSIS TOOLS:**

- Bode plot, Nyquist plot,
- 2D and 3D orbit analysis,
- 2D and 3D shaft centerline
- Run Out Compensation,
- Magnetic flux shorted turns detection
- FFT spectrum, CPB spectrum
- Waterfall spectrum

**EXPERT DATA ANALYSIS TOOLS:**

- Bearing and structure stiffness identification
- Statistical analysis of machine operation
- Torsion vibrations identification

# CoDiS SOFTWARE

## HOME SCREEN

- Display of main operational parameters for each unit:
  - Vibrations
  - Process quantities
- Alarm indication
- Navigation buttons

This display can be completely tailored to customer needs.

## REAL TIME DISPLAY

Tab control separated by groups:

- Vibrations (Relative shaft vibrations, Absolute bearing housing vibrations)
- Process quantities
- Temperatures

Each condition vector component can be displayed as short real time trend (e. g. 10-30 min.).

## ANALYSIS TOOLS

### TREND DATABASE DISPLAY (LONG TERM) HISTORY, TRENDS:

- Daily data storage organization (selectable from one day to multiple days/months)
- Operating condition filter display
- Data export to ASCII

### RUN UP/COAST DOWN DATABASE DISPLAY:

- Each day has list of transient events
- Data recorded with highest resolution (0.5s, 1s, 2s selectable)
- Post processing analysis available:
  - Shaft centerline 2D and 3D, Nyquist and Bode, 2D and 3D orbits, RunOut compensation, shaft run out in 3D

### EVENT ANALYSIS (ALARM OR USER CREATED)

- Waveform raw data display (with pre-trigger)
- Spectrum analysis (CPB, Waterfall)
- Order analysis (Orbit display)

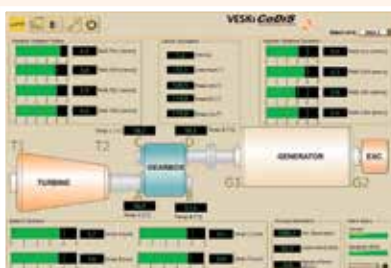

Main Screen

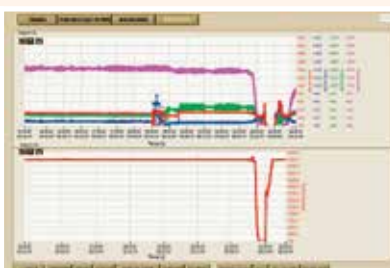

Trends

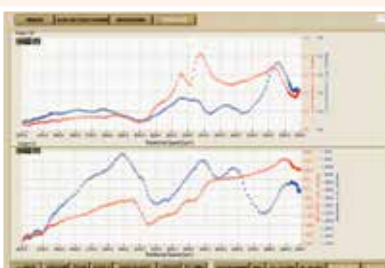

Bode plot



Nyquist plot

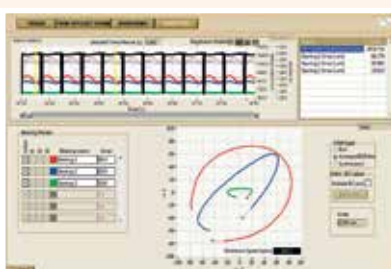

Orbit plot

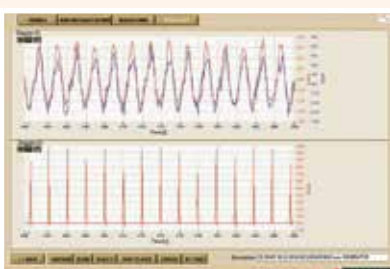

Raw data analysis

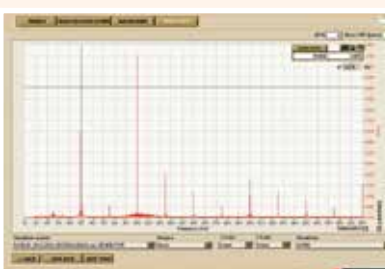

2D Spectrum

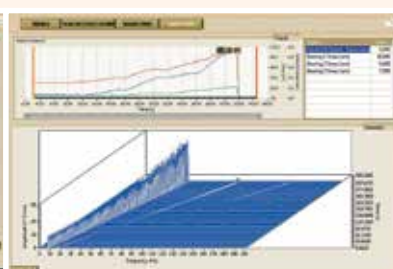

Waterfall spectrum

## GAS TURBINE-GENERATOR

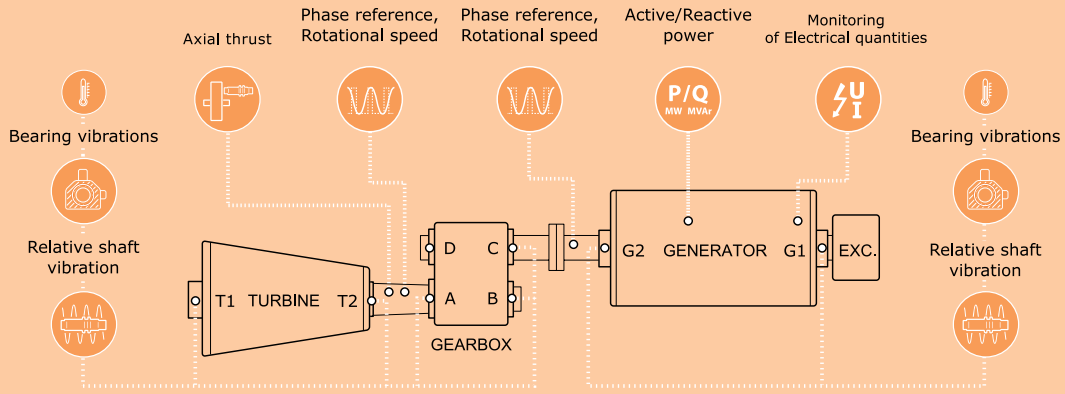

## MOTOR-COMPRESSOR or BLOWER

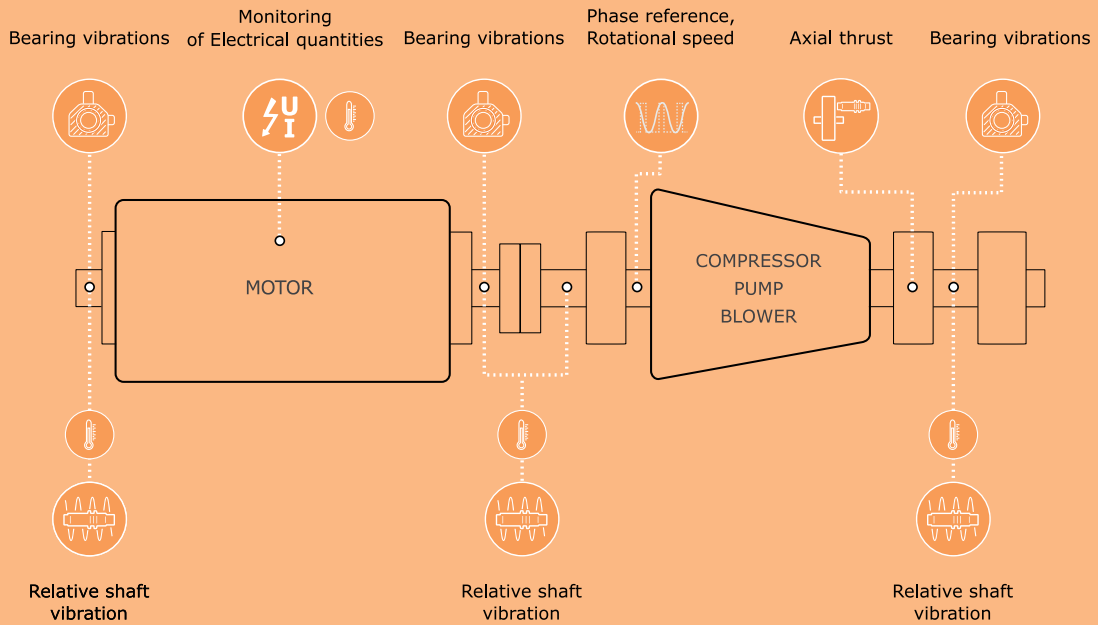

## MOTOR- HORIZONTAL PUMP

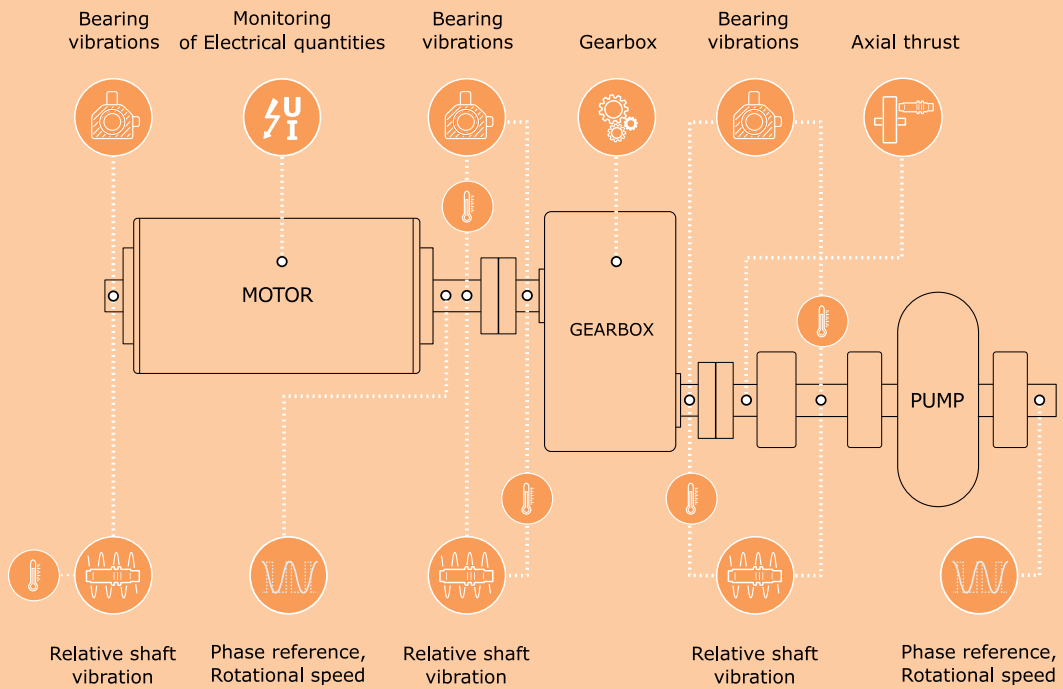

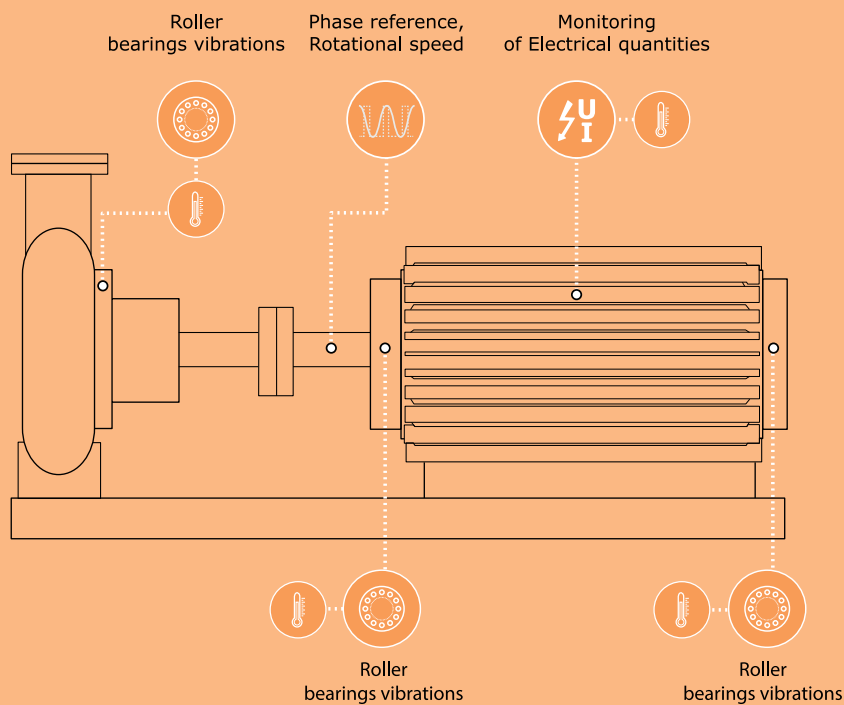

### MOTOR- VERTICAL PUMP

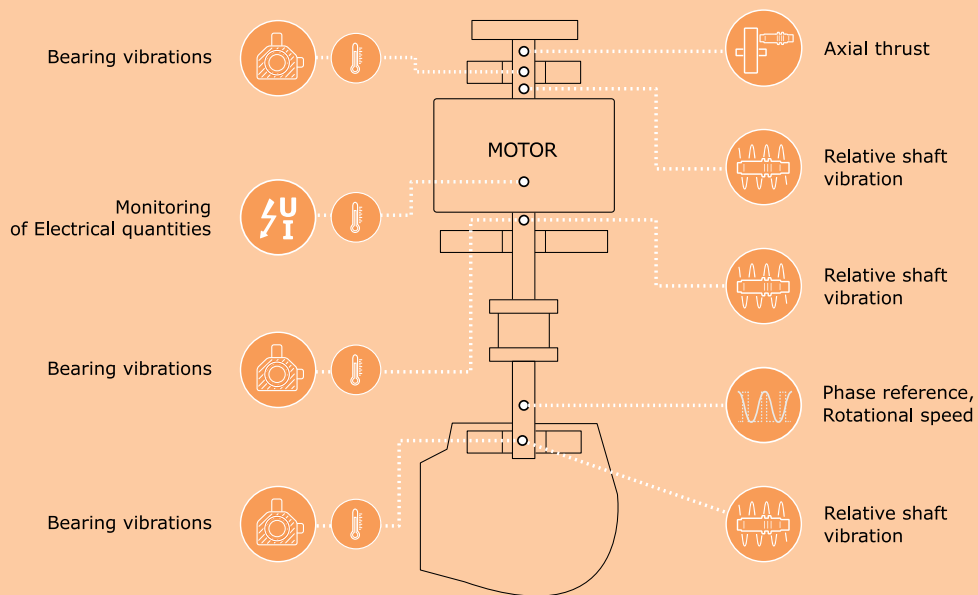

### MOTOR-FAN

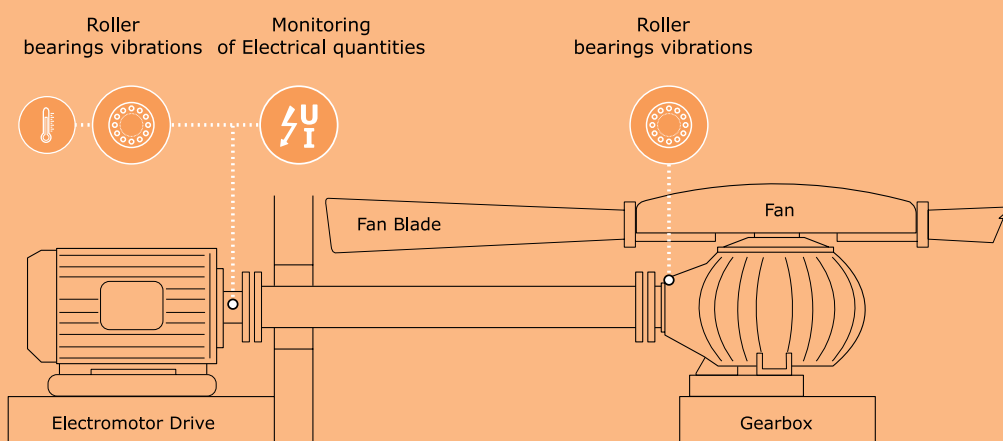

Solutions only



Veski Ltd  
Oreškovićeva 8j  
10 000 Zagreb, Croatia

Tel: +385 1 3667 133  
Fax: +385 1 3667 155

E-mail: [info@veski.hr](mailto:info@veski.hr)  
Web: [www.veski.hr](http://www.veski.hr)



ISO 9001  
Q-480